

**Soft Served
 Portofino Soft Ice Cream Dispenser, 2
 flavours+1mix, electr.control&touch
 panel, 600cones/h-pump**

ITEM # _____

MODEL # _____

NAME # _____

SIS # _____

AIA # _____

560075 (POR214DPA3PH)

Soft ice cream dispenser with 2x8 l tank capacity and 1,95 l cylinder volume, 2 flavours + 1 mix, electrical control and touch screen panel, countertop, hourly production: 600 cones (75 gr), pump version, R452A

Short Form Specification

Item No. _____

Soft ice cream and frozen yogurt dispenser with 2x8 l tank capacity and 1,95 l cylinder volume, 2 flavours + 1 mix, hourly production: 600 cones (75 gr). Digital control and touch screen panel. It is a countertop appliance with pump system. The tank agitator and the stainless steel drip tray are included as standard. R452a as refrigerant gas. Air-cooled version: requires no water connections that means less operating costs and it is easy to install.

Main Features

- It delivers soft ice cream and frozen yogurt.
- Thanks to the pump feeding system, the equipment incorporates more air - high overrun - and therefore the dispensed ice cream is lighter and softer. High overrun means higher profit.
- Digital control with touch screen.
- The machine is equipped with tank agitator and stainless steel drip tray.
- It delivers up to 600 cones/h (75 gr.) of soft ice cream and frozen yogurt.
- Countertop appliance with pump delivers soft ice cream and frozen yogurt, two-flavor equipment.
- The machine is equipped with two tanks of 8 liters capacity and dispenses 600 cones/h (75gr cones).

Construction

- Air-cooled version requires no water connections that means low operating costs and easy installation.
- Environmentally friendly: R452a as refrigerant gas.

APPROVAL: _____



Electrolux
PROFESSIONAL

Soft Served
Portofino Soft Ice Cream Dispenser, 2
flavours+1mix, electr.control&touch panel,
600cones/h-pump

Front

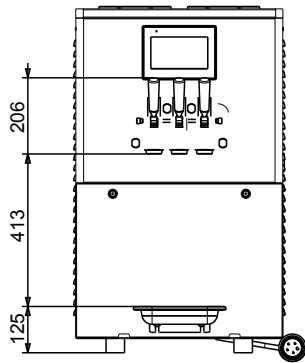

Side

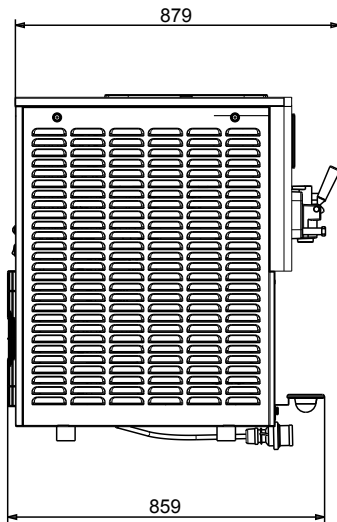

Top

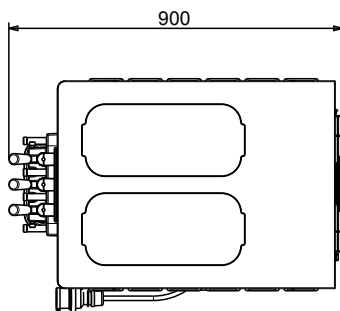

Electric

Supply voltage:

560075 (POR214DPA3PH) 380-400 V/3N ph/50 Hz

Electrical power max.:

4.5 kW

Key Information:

External dimensions, Width: 572 mm

External dimensions, Depth: 875 mm

External dimensions, Height: 931 mm

Net weight: 201 kg

Freezing cylinder capacity: 1.95 l

Preparation system: Pump

N° of hoppers/grinders: 2

Hopper capacity: 8 l

Plug type: IEC/EN 60309-1/2

Refrigeration Data

Operating temperature min.: 20 °C

Operating temperature max.: 40 °C

Sustainability

Refrigerant type: R452A



Soft Served
Portofino Soft Ice Cream Dispenser, 2 flavours+1mix, electr.
control&touch panel, 600cones/h-pump
The company reserves the right to make modifications to the products
without prior notice. All information correct at time of printing.

2024.05.17